



Technical Data - Electrical Ratings

Voltage Supply	12VDC / 24VDC
Signal Type	Continuous
Light Colors	Red, Yellow, Green *
Power Consumption	R:1,4W Y:0,9W G:0,9W Bzr:0,5W
Connection	Cable
Buzzer Output	92 dB @ 1 Meter
Buzzer Tone Type	Pulse
Dimensions	50 x 77 x 444 mm
Weight Approx	500g
Protection	IP65
Body Material	Anodized Aluminium
Mounting	Base Mount
Luminous Source	LED
Lens Material	Polycarbonate
Temperature Range	-20°C to +50° C

* Inquire for other modes

Technical Drawings

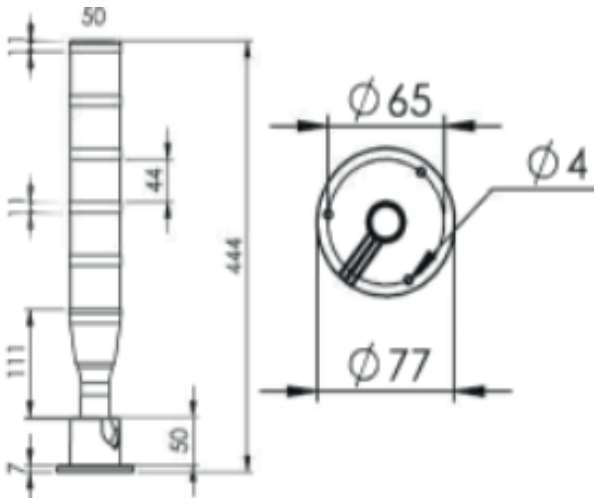

Connections

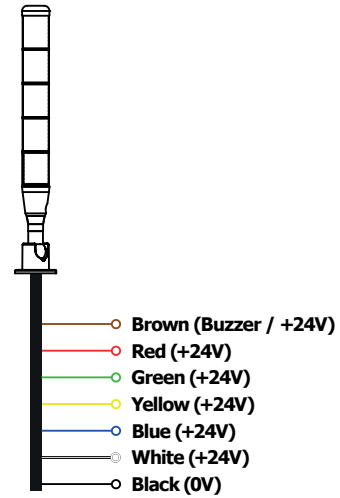

Code Key

İL - XPROB - 245B

SERIES

Pro Series Light

BUZZER

Blank : No Buzzer
B : With Buzzer

SUPPLY VOLTAGE

12 : 12 VAC/VDC
24 : 24 VAC/VDC

NUMBER OF SEGMENTS

1 : R
2 : R / G
3 : R / G / Y
4 : R / G / Y / B
5 : R / G / Y / B / W