

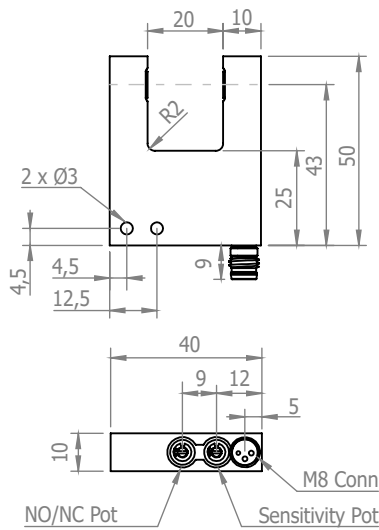

Technical Data - Electrical Ratings

Voltage Supply	10 to 30 VDC
Insulation Voltage Endurance	500 V
Rated Output Current	120 mA
No Load Current	<35 mA
Switching Frequency	250 Hz
Output	NPN NO/NC, PNP NO/NC
Operating Principle	Optical
Resolution	0,4 mm
Evaluation	Static
Sensitivity	Adjustable
Emitted Light	Red Light
Ambient Light Immunity	50 klx
Branch Length Inside	25 mm
Fork Opening Length	20 mm
Connection	M8 3 Pin Male Connector
Dimensions	40 x 50 x 10 mm
Weight Approx	30 g
Body Material	Anodized Aluminium
Temperature Range	-25°C to +60° C
Protection	IP65
Degree of Protection	III, Safety Extra-Low Voltage
Conforming Standard	EN 60947-5-2
Country of Origin	TR

Technical Drawing



Connection

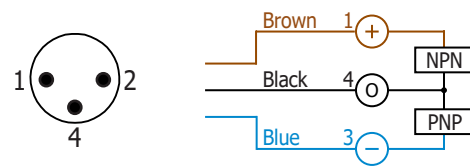

Code Key

OFKM 20P35 / L83

OFKM SERIES

FORK OPENING SIZE

- 10 : 10 mm
- 20 : 20 mm
- 30 : 30 mm
- 40 : 40 mm
- 50 : 50 mm
- 80 : 80 mm
- 120 : 120 mm

OUTPUT SIGNAL

- N : NPN
- P : PNP

CONNECTION

- L83 : M8 3 Pin Male Connector
- L84 : M8 4 Pin Male Connector
- KS : Cable

SENSITIVITY

- Blank : Fixed (for OFKM10 only)
- 5 : Adjustable With Potansiometer

OPERATION TYPE

- 1 : Light Operate (for OFKM10 Only)
- 3 : Light / Dark Operate